

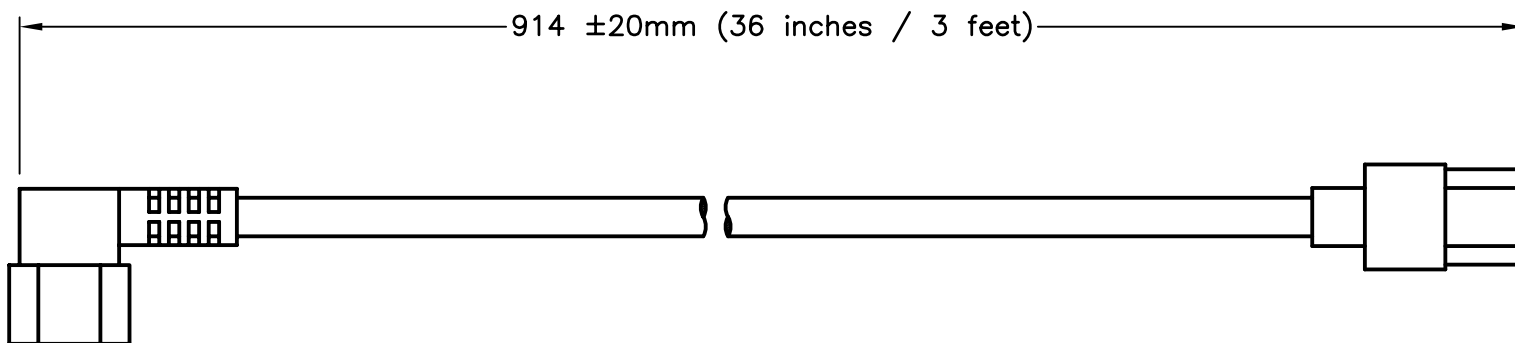

APPROVALS	CSA <input checked="" type="checkbox"/> UL <input checked="" type="checkbox"/>
CERTIFICATIONS	ROHS <input checked="" type="checkbox"/>
STANDARDS	IEC 60320 <input checked="" type="checkbox"/>

ALL DIMENSIONS ARE IN MILLIMETERS



IEC 60320
C-13, STRAIGHT

IEC 60320
C-14, LEFT ANGLE

SPECIFICATIONS:

1. OVERALL LENGTH: 914 mm (36 inches / 3 feet)
2. CONDUCTORS: 18awg-3c
3. JACKET: SJT(OW), BLACK
4. PLUG: IEC 60320 C14, LEFT ANGLE, BLACK
5. CONNECTOR: IEC 60320 C13, STRAIGHT, BLACK
6. RATED: 10 AMPERE 250 VOLT
7. PUT-UP: BULK
8. WEIGHT (APPROX): 0.27 LBS / 0.12 Kg
9. MISCELLANEOUS:

WORLD CORD SETS, INC.			
TEL (860)763-2100		www.WorldCordSets.com	
FAX (860)763-1183		sales@WorldCordSets.com	
TITLE			
DETACHABLE CORD SET C14LA C13 3FT 10A 250V			
SCALE	DATE	PART NO.	REV
NONE	08-30-2012	14L13-F-036	-

THIS DOCUMENT AND THE INFORMATION CONTAINED HEREIN ARE THE PROPRIETARY CONFIDENTIAL PROPERTY OF WORLD CORD SETS. NO USE OR REPRODUCTION IN PART OR WHOLE MAY BE MADE WITHOUT WRITTEN PERMISSION FROM WORLD CORD SETS.