

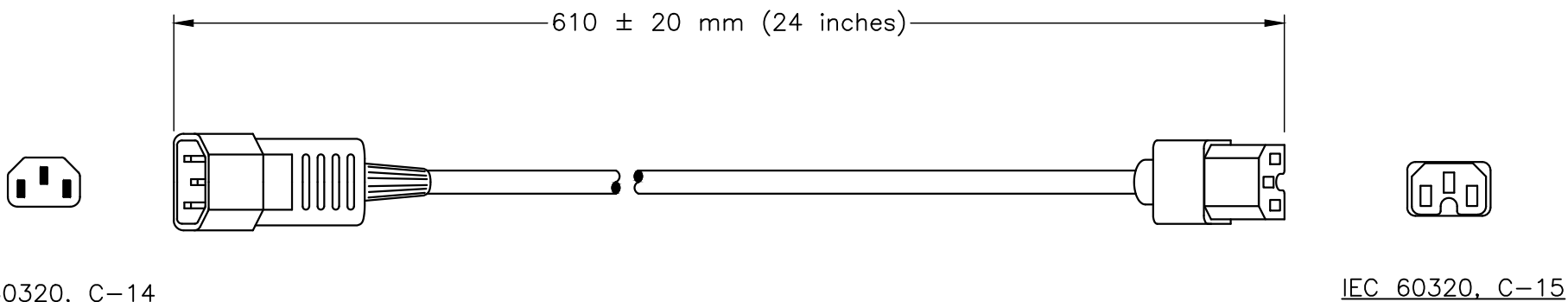

APPROVALS	C-UL <input checked="" type="checkbox"/> UL <input checked="" type="checkbox"/>
CERTIFICATIONS	ROHS <input checked="" type="checkbox"/>
STANDARDS	IEC 60320 <input checked="" type="checkbox"/>



SPECIFICATIONS:

1. OVERALL LENGTH: 610 ± 20 mm (24 inches)
2. CONDUCTORS: 14 AWG x 3
3. JACKET: SJTOW, 105°C, GREEN
4. PLUG: IEC 60320 C-14, STRAIGHT, GREEN
5. CONNECTOR: IEC 60320 C-15, STRAIGHT, GREEN
6. RATED: 15 AMPERE 250 VOLT
7. PUT-UP: COILED
8. WEIGHT: 0.24 lb / 0.11 kg
9. MISCELLANEOUS

ALL DIMENSIONS ARE IN MILLIMETERS

WORLD CORD SETS, INC.			
TEL (860)763-2100		www.WorldCordSets.com	
FAX (860)763-1183		sales@WorldCordSets.com	
TITLE			
C14 C15 14/3 SJT(OW) BLACK			
SCALE	DATE	PART NO.	REV
NONE	04-07-2016	1415-H-018-GRN	-

THIS DOCUMENT AND THE INFORMATION CONTAINED HEREIN ARE THE PROPRIETARY CONFIDENTIAL PROPERTY OF WORLD CORD SETS. NO USE OR REPRODUCTION IN PART OR WHOLE MAY BE MADE WITHOUT WRITTEN PERMISSION FROM WORLD CORD SETS.