

APPROVALS	CSA <input checked="" type="checkbox"/>	UL <input checked="" type="checkbox"/>	VDE <input checked="" type="checkbox"/>
CERTIFICATIONS	CE <input checked="" type="checkbox"/>	ROHS <input checked="" type="checkbox"/>	
STANDARDS	IEC 60320 <input checked="" type="checkbox"/>		

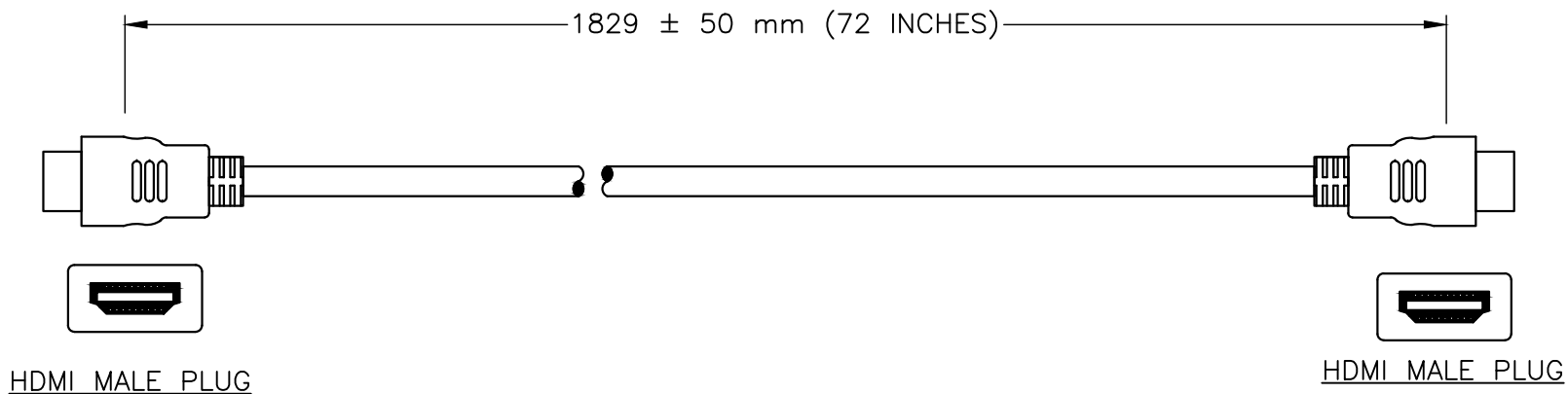

SPECIFICATIONS:

1. OVERALL LENGTH: 6 FEET
2. CONDUCTORS: 28 AWG, .217 INCH DIAMETER
3. PLUG: HDMI MALE PLUG, BLACK
4. CONNECTOR: HDMI MALE PLUG, BLACK
5. PUT-UP: COILED
6. WEIGHT (APPROX): 0.2 LBS / 0.09 Kg
7. MISCELLANEOUS:

WORLD CORD SETS, INC.

TEL (860)763-2100
FAX (860)763-1183



www.WorldCordSets.com
sales@WorldCordSets.com

TITLE
HDMI CABLE HIGH SPEED WITH ETHERNET 1080p

THIS DOCUMENT AND THE INFORMATION CONTAINED HEREIN ARE THE PROPRIETARY CONFIDENTIAL PROPERTY OF WORLD CORD SETS. NO USE OR REPRODUCTION IN PART OR WHOLE MAY BE MADE WITHOUT WRITTEN PERMISSION FROM WORLD CORD SETS.

SCALE NONE	DATE 6/4/2018	PART NO. HDMI1080.072	REV —
---------------	------------------	---------------------------------	----------