

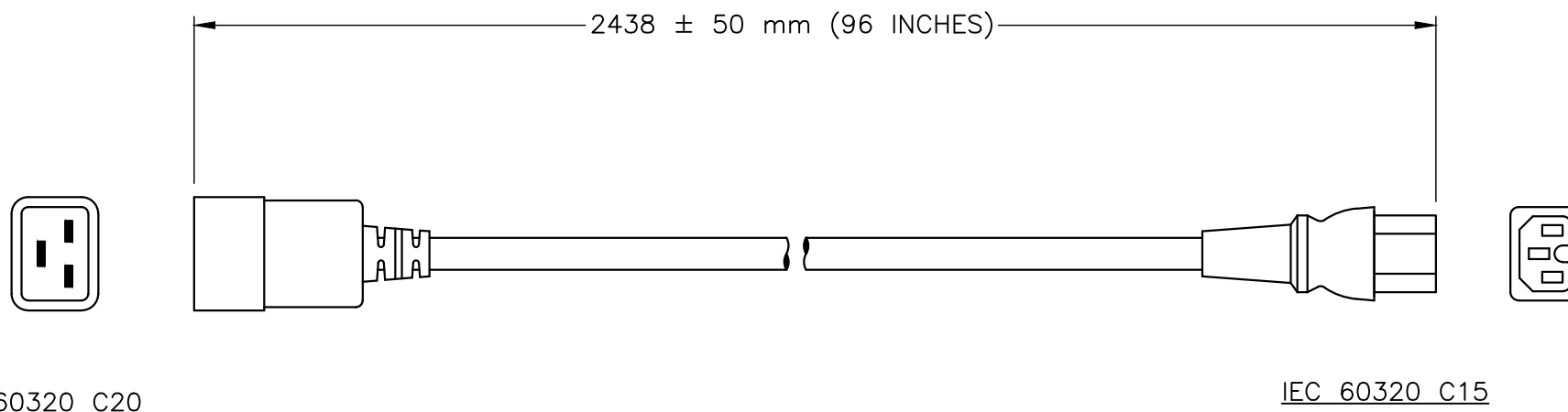

STANDARDS	IEC 60320 <input checked="" type="checkbox"/>
APPROVALS	C-UL <input checked="" type="checkbox"/> UL <input checked="" type="checkbox"/>
CERTIFICATIONS	ROHS <input checked="" type="checkbox"/>



SPECIFICATIONS:

1. LENGTH: 2438 ± 50 mm (96 INCHES)
2. CONDUCTORS: 14awg-3c
2. JACKET: SJT, 105°C, BLACK
3. PLUG: IEC60320 C20, STRAIGHT, BLACK
4. CONNECTOR: IEC60320 C15, STRAIGHT, BLACK
5. RATED: 15A 250V
6. MISCELLANEOUS:

WORLD CORD SETS, INC.			
TEL (860)763-2100			www.WorldCordSets.com
FAX (860)763-1183			sales@WorldCordSets.com
TITLE			
8FT C20 C15 14awg-3c SJT 105c BLACK			
SCALE	DATE	PART NO.	REV
NONE	03-16-2018	2015-H-096	-

THIS DOCUMENT AND THE INFORMATION CONTAINED HEREIN ARE THE PROPRIETARY CONFIDENTIAL PROPERTY OF WORLD CORD SETS. NO USE OR REPRODUCTION IN PART OR WHOLE MAY BE MADE WITHOUT WRITTEN PERMISSION FROM WORLD CORD SETS.