

APPROVALS	UL <input checked="" type="checkbox"/>	CSA <input checked="" type="checkbox"/>
CERTIFICATIONS	ROHS <input checked="" type="checkbox"/>	
STANDARDS	IEC 60320 <input checked="" type="checkbox"/>	

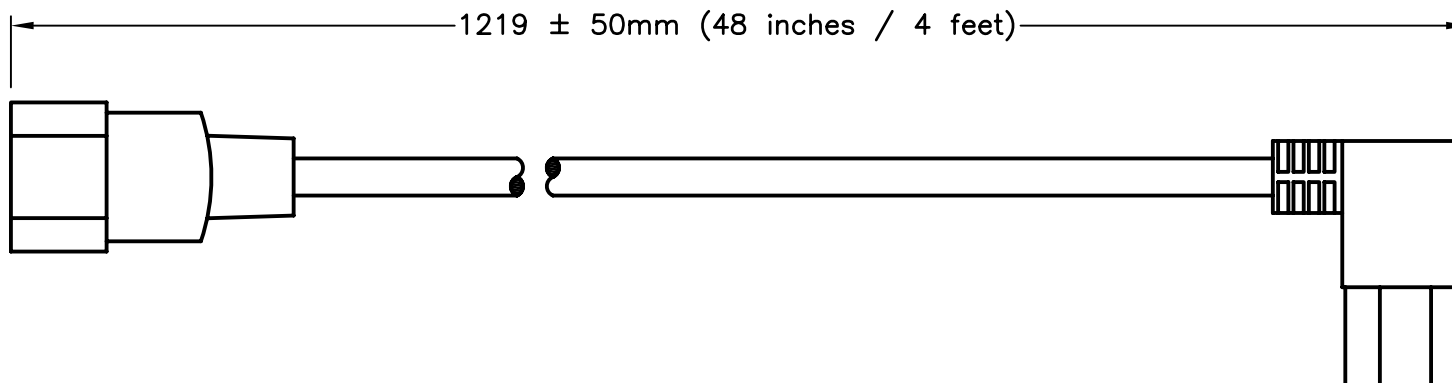

IEC 60320, C-14
STRAIGHT
(VIEW ROTATED 90°)



IEC 60320, C-13
RIGHT ANGLE

SPECIFICATIONS:

1. OVERALL LENGTH: 1219 mm (48 inches / 4 feet)
2. CONDUCTORS: 18awg-3c
3. JACKET: SJT, BLACK
4. PLUG: C-14, STRAIGHT, BLACK
5. CONNECTOR: IEC 60320 C-13, RIGHT ANGLE, BLACK
6. RATED: 10 AMPERE 250 VOLT
7. APPROVALS: UL, CSA
8. PUT-UP: BULK
9. APPROX. WEIGHT: 0.33 LBS (0.15 kg)

WORLD CORD SETS, INC.			
TEL (860)763-2100		www.WorldCordSets.com	
FAX (860)763-1183		sales@WorldCordSets.com	
TITLE			
DETACHABLE CORDSET C14 C13RA 4FT 10A 250V			
SCALE	DATE	PART NO.	REV
NONE	08-29-2012	1413R-F-048	-

THIS DOCUMENT AND THE INFORMATION CONTAINED HEREIN ARE THE PROPRIETARY CONFIDENTIAL PROPERTY OF WORLD CORD SETS. NO USE OR REPRODUCTION IN PART OR WHOLE MAY BE MADE WITHOUT WRITTEN PERMISSION FROM WORLD CORD SETS.