

APPROVALS	UL <input checked="" type="checkbox"/> CSA <input checked="" type="checkbox"/>
CERTIFICATIONS	ROHS <input checked="" type="checkbox"/>
STANDARDS	IEC 60320 <input checked="" type="checkbox"/>

IEC 60320, C-13
LEFT ANGLE

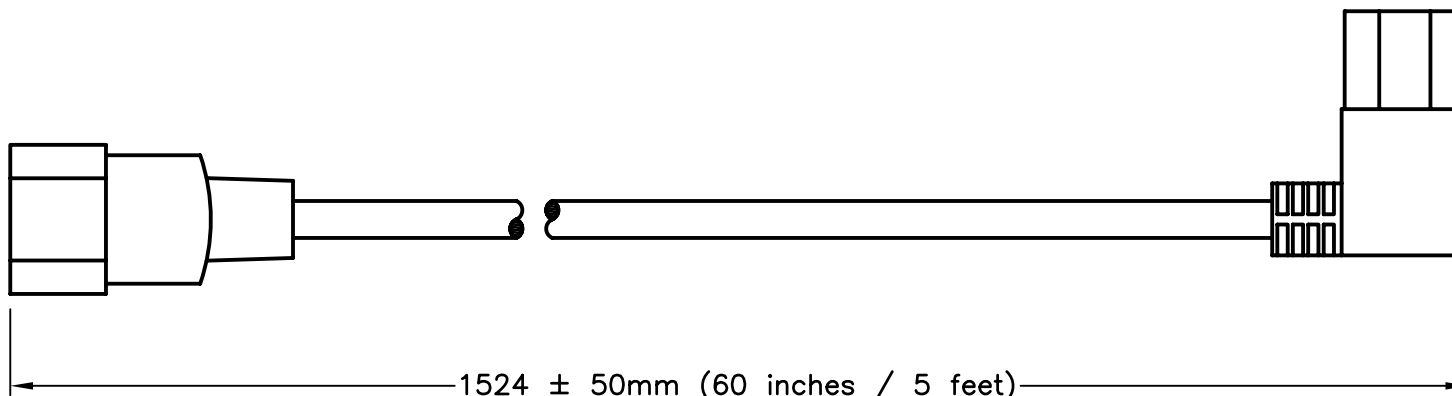

IEC 60320, C-14
STRAIGHT
(VIEW ROTATED 90°)



SPECIFICATIONS:

1. OVERALL LENGTH: 1524 mm (60 inches / 5 feet)
2. CONDUCTORS: 18awg-3c
3. JACKET: SJT, BLACK
4. PLUG: C-14, STRAIGHT, BLACK
5. CONNECTOR: IEC 60320 C-13, LEFT ANGLE, BLACK
6. RATED: 10 AMPERE 250 VOLT
7. APPROVALS: UL, CSA
8. PUT-UP: BULK
9. APPROX. WEIGHT: 0.40 LBS (0.18 kg)

WORLD CORD SETS, INC.

TEL (860)763-2100
FAX (860)763-1183



www.WorldCordSets.com
sales@WorldCordSets.com

TITLE
DETACHABLE CORDSET C14 C13LA 5FT 10A 250V

THIS DOCUMENT AND THE INFORMATION CONTAINED HEREIN ARE THE PROPRIETARY CONFIDENTIAL PROPERTY OF WORLD CORD SETS. NO USE OR REPRODUCTION IN PART OR WHOLE MAY BE MADE WITHOUT WRITTEN PERMISSION FROM WORLD CORD SETS.

SCALE NONE	DATE 08-29-2012	PART NO. 1413L-F-060	REV -
---------------	--------------------	-------------------------	----------